

带座外球面球轴承

UCP2立式带座外球面向心球轴承组件带止动螺钉

钉-UCP204-012D1+UC204-012D1+P204D1Z(ZM)-UCP204-012D1C(CM)-UCP204-012D1

参数信息:

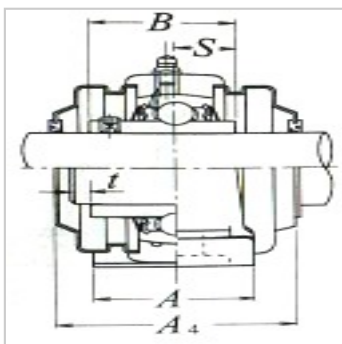
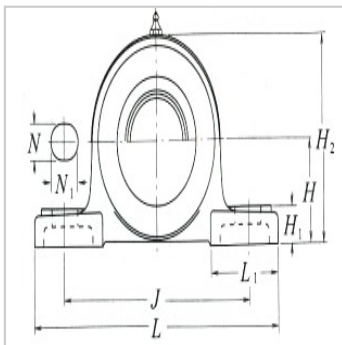
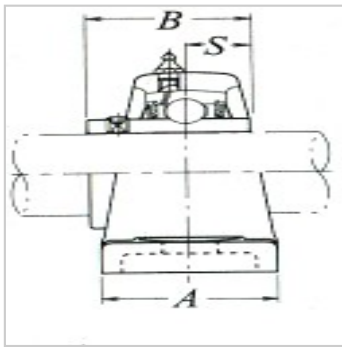
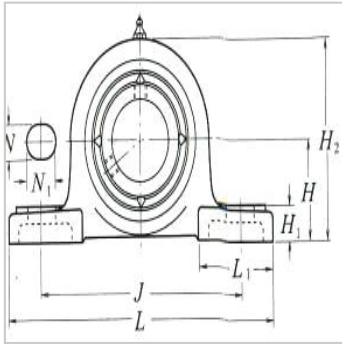

轴径inch :	3/4
座组件轴承型号(1) :	UCP204-012 D1

尺寸inch :	
H :	1 5/16
L :	5
J :	3 3/4
A :	1 1/2
N :	1/2
N :	5/8
H :	9/16
H :	2 9/16
L :	1 21/32
B :	1.2205
S :	0.5

安装螺栓规格inch :	3/8
--------------	-----

轴承代号 :	UC204-01 2D1
--------	-----------------

座外型号 :	P204D1
--------	--------

带钢板外罩座组件轴 承型号 :	Z(ZM)-U CP204-01 2D1
--------------------	----------------------------

带铸铁外罩座组件轴 承型号 :	C(CM)-U CP204-01 2D1
--------------------	----------------------------

尺寸inch :	
t(最大) :	5/64
A :	1 25/32
H :	2 3/4
A :	2 7/16

带座轴承重量lb :

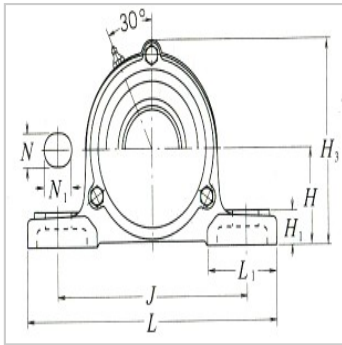

UCP :	1.5
Z(ZM) :	1.5
C(CM) :	2.2

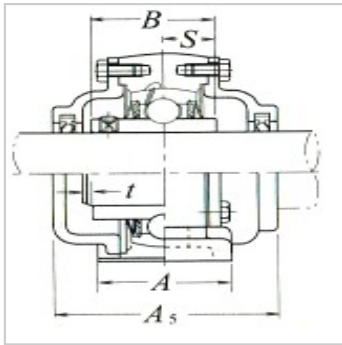

: