

带座外球面球轴承

UCP2立式带座外球面向心球轴承组件带止动螺钉-UCP204D1+UC204D1+P204D1Z(ZM)-UCP204D1C(CM)-UCP204D1

参数信息:

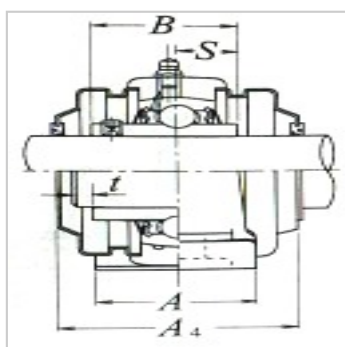
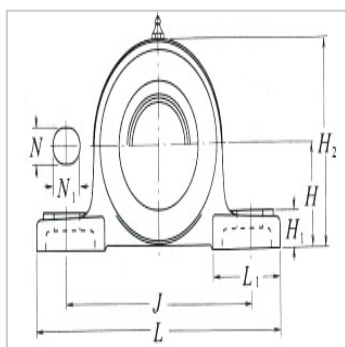
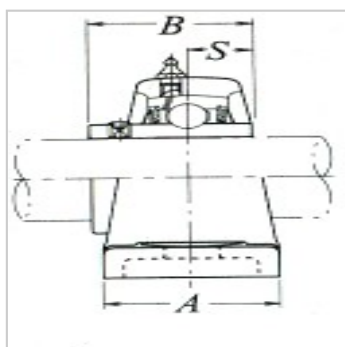
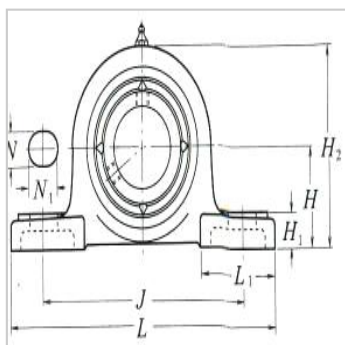

轴径inch :	20
座组件轴承型号(1) :	UCP204D1
尺寸inch :	
H :	33.3
L :	127
J :	95
A :	38
N :	13
N :	16
H :	14
H :	65
L :	42
B :	31
S :	12.7
安装螺栓规格inch :	M10
轴承代号 :	UC204D1
座外型号 :	P204D1
带钢板外罩座组件轴承型号 :	Z(ZM)-UCP204D1
带铸铁外罩座组件轴承型号 :	C(CM)-UCP204D1
尺寸inch :	
t(最大) :	2
A :	45
H :	70
A :	62
带座轴承重量lb :	
UCP :	0.7
Z(ZM) :	0.7

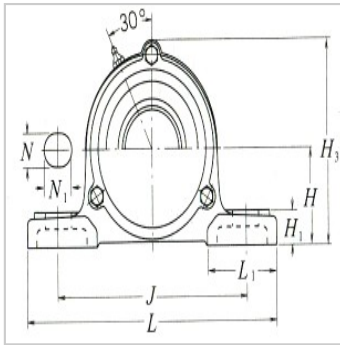

C(CM) : 1.0

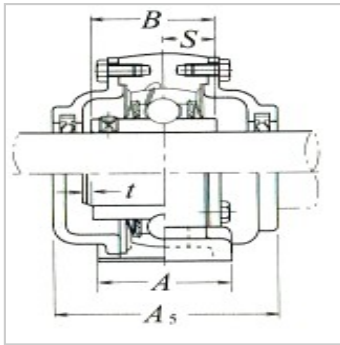

: